

Model No.: OX20SC00-04

Rev: 2

Product Line: Tymphany

Last Update: 2019-05-08 02:44:58

Product Description

This OX family tweeter features a 19 mm diameter 4 ohm voice coil, a damped silk diaphragm with large surround roll, a neodymium magnet motor to produce a compact motor, and a metal rear chamber to provide both a lower resonant frequency and added heat sinking for power handling capacity. The product is designed to fit snugly into small applications, while providing excellent dynamic sound quality.



Mechanical Drawing

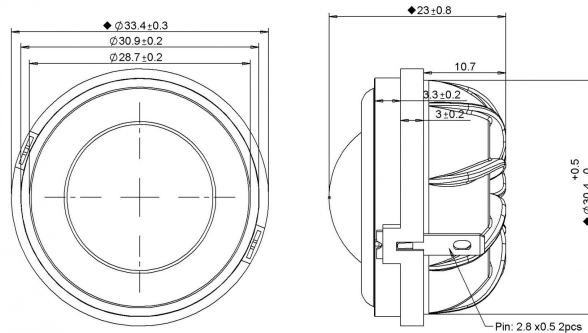

Specifications

DC Resistance	Revc	Ohms	3.28	5.0%	Energy Bandwidth Product	EBP	(1/Qes)*fs
Minimum Impedance	Zmin	Ohms	3.46	7.5%	Moving Mass	Mms	g
Voice Coil Inductance	Le	mH	0.01		Suspension Compliance	Cms	um/N
Resonant Frequency	Fs	Hz	1024.9	15%	Effective Cone diameter	D	cm
Mechanical Q Factor	Qms		9.46		Effective Piston Area	Sd	cm ²
Electrical Q Factor	Qes		1.83		Effective Volume	Vas	L
Total Q Factor	Qts		1.53		Motor Force Factor	BL	Tm
Ratio Fs/Qts	F	Fs/Qts	669.87		Motor Efficiency Factor	β	(T*M ²)/Ohms
Half Space Sensitivity @2.83V	db@2.83V/1M	dB	90.71	+/- 1.0db	Voice coil former Material	VCfm	ASV
Half Space Sensitivity @1W/1M	db@1W/1M	dB	87.1	+/- 1.0db	Voice coil inner diameter	VCd	mm
Gap Height	Gh	mm	2		Rated Noise Power	P	W
Maximum Linear Excursion	Xmax	mm	0.1		Test Spectrum Bandwidth		2.5kHz - 20kHz
Ferrofluid Type	FF				Driver Size	Inch	19 mm
Driver Mass	Kg		0.04				

Frequency and Impedance Response

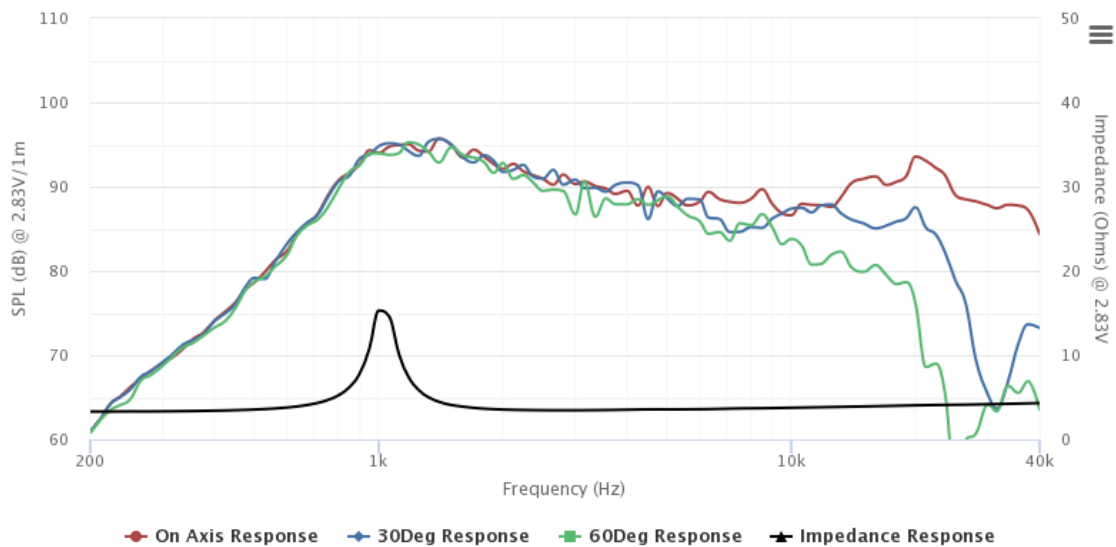

Highcharts.com