

Model No.: D19TD05-08
 Product Line: Tymphany

Rev: 1
 Last Update: 2017-04-25 21:32:09

Product Description

This D family tweeter features an 8ohm 19mm voice coil, a treated fabric dome, with a ferrite magnet and a ABS faceplate, and ferrofluid in the gap of the ferrite magnet motor, providing enhanced cooling of the voice coil. Is designed to be a high performance transducer.



Mechanical Drawing

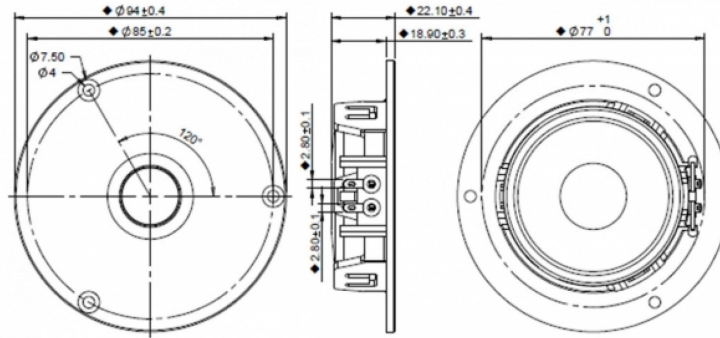

Specifications

DC Resistance	Revc	Ohms	6.33	5.0%	Energy Bandwidth Product	EBP	(1/Qes)*fs
Minimum Impedance	Zmin	Ohms	7.64	7.5%	Moving Mass	Mms	g
Voice Coil Inductance	Le	mH	0.02		Suspension Compliance	Cms	um/N
Resonant Frequency	Fs	Hz	1687.93	15%	Effective Cone diameter	D	cm
Mechanical Q Factor	Qms		1.08		Effective Piston Area	Sd	cm^2
Electrical Q Factor	Qes		1.94		Effective Volume	Vas	L
Total Q Factor	Qts		0.69		Motor Force Factor	BL	Tm
Ratio Fs/Qts	F	Fs/Qts	2432.18		Motor Efficiency Factor	β	(T*M^2)/Ohms
Half Space Sensitivity @2.83V	db@2.83V/1M	dB	87.74	+/- 1.0db	Voice coil former Material	VCfm	ASV
Half Space Sensitivity @1W/1M	db@1W/1M	dB	87.5	+/- 1.0db	Voice coil inner diameter	VCd	mm
Gap Height	Gh	mm	2		Rated Noise Power	P	W
Maximum Linear Excursion	Xmax	mm	0.4		Test Spectrum Bandwidth		1KHz-20KHz
Ferrofluid Type	FF		APG087		Driver Size	Inch	19 mm
Driver Mass	Kg		0.28				

Frequency and Impedance Response

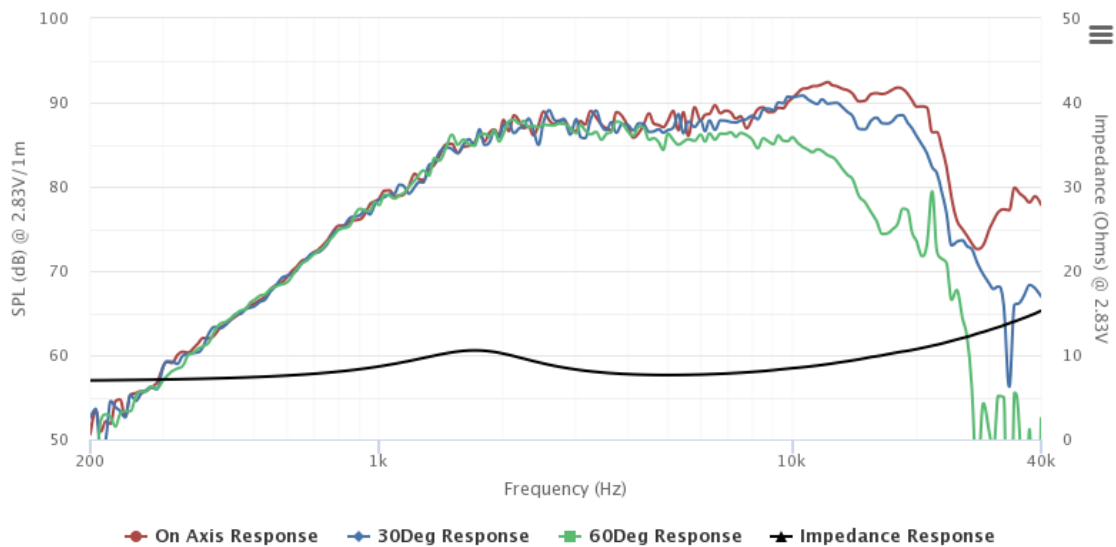

Highcharts.com