

Model No.: DX25TG59-04

Rev: 1

Product Line: Tympany

Last Update: 2017-03-03 02:00:02

Product Description

This DX family tweeter features a 4 ohm 25 mm ferrofluid-cooled voice coil, a damped silk diaphragm with large surround roll to produce a low resonant frequency, and a ferrite magnet motor which adds heat sinking for power handling capacity. The faceplate features recessed mounting holes to minimize reflections.



Mechanical Drawing

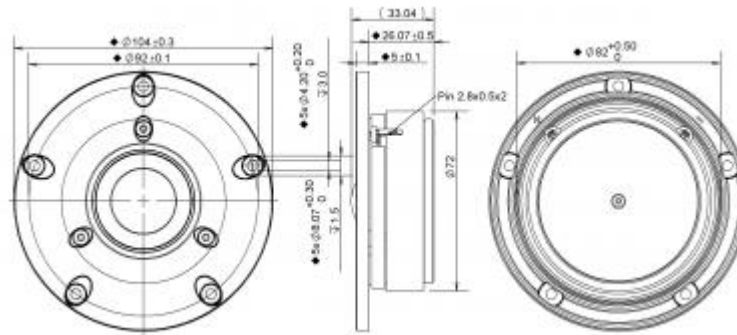

Specifications

DC Resistance	Revc	Ohms	2.93	5.0%	Energy Bandwidth Product	EBP	(1/Qes)*fs
Minimum Impedance	Zmin	Ohms	3.78	7.5%	Moving Mass	Mms	g
Voice Coil Inductance	Le	mH	0.02		Suspension Compliance	Cms	um/N
Resonant Frequency	Fs	Hz	640.02	15%	Effective Cone diameter	D	cm
Mechanical Q Factor	Qms		2.46		Effective Piston Area	Sd	cm^2
Electrical Q Factor	Qes	0.74			Effective Volume	Vas	L
Total Q Factor	Qts		0.57		Motor Force Factor	BL	Tm
Ratio Fs/Qts	F	Fs/Qts	1128.79		Motor Efficiency Factor	β	(T*M^2)/Ohms
Half Space Sensitivity @2.83V	db@2.83V/1M	dB	93.02	+/- 1.0db	Voice coil former Material	VCfm	ASV
Half Space Sensitivity @1W/1M	db@1W/1M	dB	89.8	+/- 1.0db	Voice coil inner diameter	VCd	mm
Gap Height	Gh	mm	2		Rated Noise Power	P	W
Maximum Linear Excursion	Xmax	mm	0.1		Test Spectrum Bandwidth		2.5KHz-20KHz
Ferrofluid Type	FF		APGS11N		Driver Size	Inch	25 mm
Driver Mass	Kg	0.5					

Frequency and Impedance Response

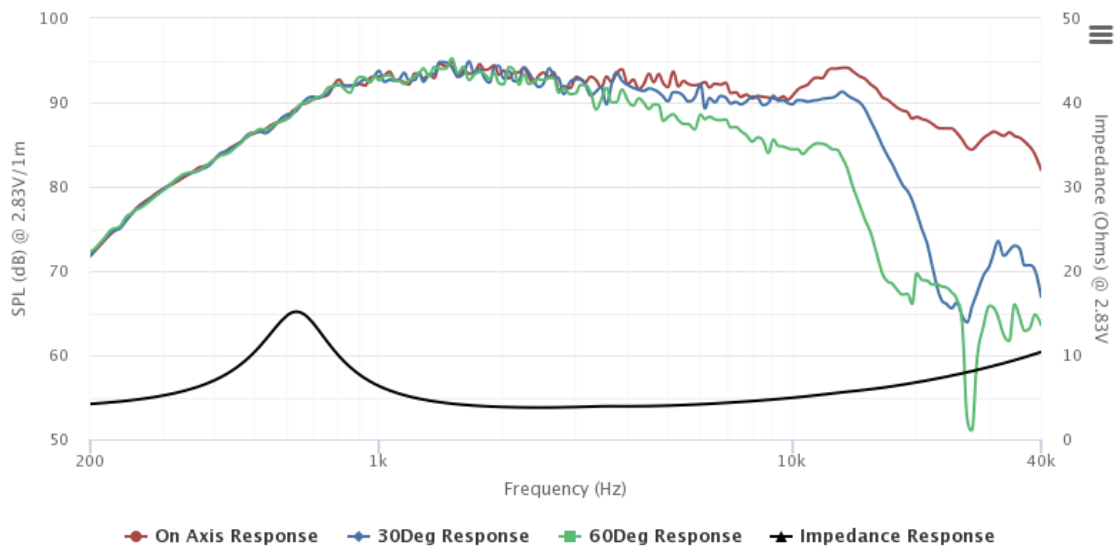

Highcharts.com