

Model No.: FLT-100N38AR02-08

Rev: 1

Product Line: Tymphany

Last Update: 2017-05-10 21:56:04

Product Description

This 4 in 8 ohm transducer is a member of the new FLT family. This family features a powerful neodymium-iron-boron magnet, nestled within an innovative suspension system featuring Plica™ technology. The flat cone is Rohacell material, skinned with black anodized aluminium. The use of these technologies together results in a very shallow form factor, thus making this product ideal for shallow applications such as LCD television soundbars.



Mechanical Drawing

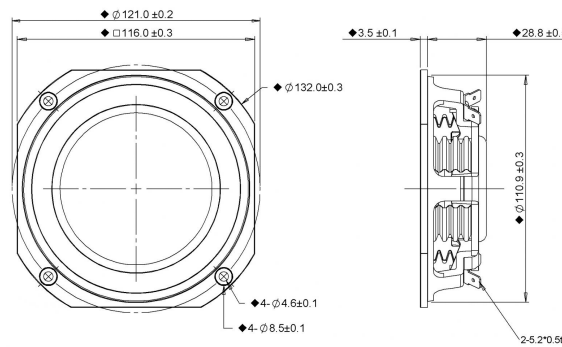

Specifications

DC Resistance	Revc	Ohms	6.74	5.0%	Energy Bandwidth Product	EBP	(1/Qes)*fs
Minimum Impedance	Zmin	Ohms	7.88	7.5%	Moving Mass	Mms	g
Voice Coil Inductance	Le	mH	0.52		Suspension Compliance	Cms	um/N
Resonant Frequency	Fs	Hz	113.03	15%	Effective Cone diameter	D	cm
Mechanical Q Factor	Qms		3.65		Effective Piston Area	Sd	cm^2
Electrical Q Factor	Qes		1.04		Effective Volume	Vas	L
Total Q Factor	Qts		0.81		Motor Force Factor	BL	Tm
Ratio Fs/Qts	F	Fs/Qts	139.54		Motor Efficiency Factor	β	(T*M^2)/Ohms
Half Space Sensitivity @2.83V	db@2.83V/1M	dB	82.82	+/- 1.0db	Voice coil former Material	VCfm	ASV
Half Space Sensitivity @1W/1M	db@1W/1M	dB	82.8	+/- 1.0db	Voice coil inner diameter	VCd	mm
Gap Height	Gh	mm	5		Rated Noise Power	P	W
Maximum Linear Excursion	Xmax	mm	2.5		Test Spectrum Bandwidth		
Ferrofluid Type	FF				Driver Size	Inch	4 in
Driver Mass	Kg		0.34				

Frequency and Impedance Response

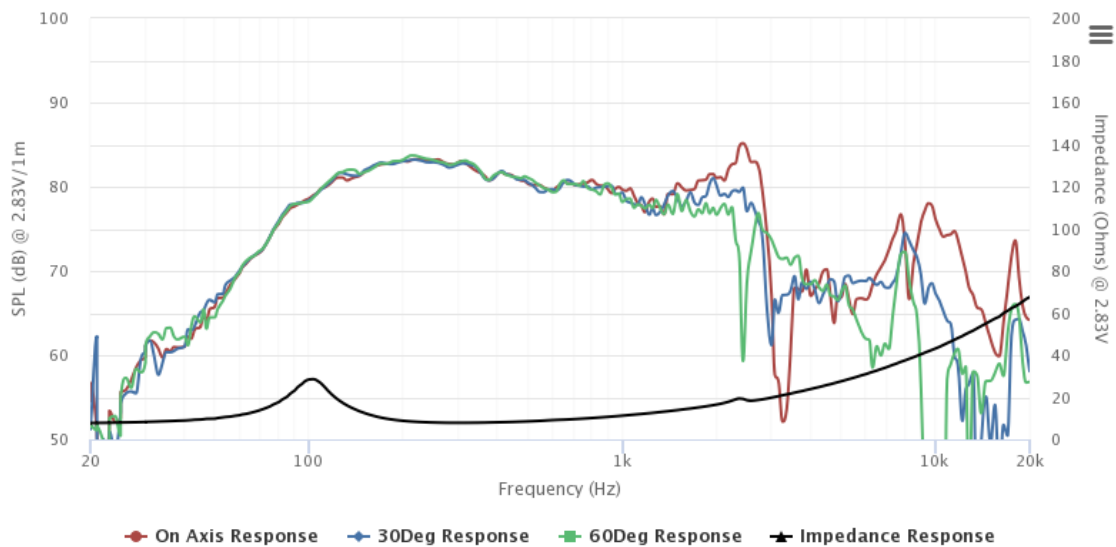

Highcharts.com