

Model No.: SDS-160F25PR01-08

Rev: 1

Product Line: Tymphany

Last Update: 2017-04-25 21:32:09

## Product Description

The SDS compact subwoofer family offers low resonant frequency performance, ideally suited for compact sealed enclosures. This 6.5 inch 8 ohm member of the SDS family offer a paper cone with rubber surround, a high power voice coil suspended in a ferrite magnet motor, and a narrow-profile steel basket shaped to fit into narrow cabinets.



## Mechanical Drawing

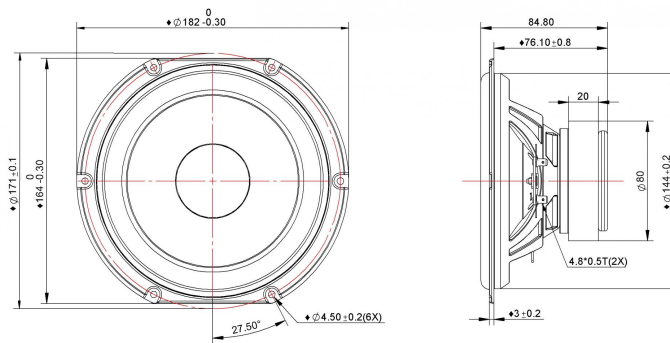

## Specifications

DC Resistance	Revc	Ohms	7.12	5.0%	Energy Bandwidth Product	EBP	(1/Qes)*fs
Minimum Impedance	Zmin	Ohms	7.98	7.5%	Moving Mass	Mms	g
Voice Coil Inductance	Le	mH	0.41		Suspension Compliance	Cms	um/N
Resonant Frequency	Fs	Hz	41.76	15%	Effective Cone diameter	D	cm
Mechanical Q Factor	Qms		2.97		Effective Piston Area	Sd	cm^2
Electrical Q Factor	Qes		0.58		Effective Volume	Vas	L
Total Q Factor	Qts		0.49		Motor Force Factor	BL	Tm
Ratio Fs/Qts	F	Fs/Qts	85.76		Motor Efficiency Factor	β	(T*M^2)/Ohms
Half Space Sensitivity @2.83V	db@2.83V/1M	dB	87.04	+/- 1.0db	Voice coil former Material	VCfm	ASV
Half Space Sensitivity @1W/1M	db@1W/1M	dB	87	+/- 1.0db	Voice coil inner diameter	VCd	mm
Gap Height	Gh	mm	6		Rated Noise Power	P	W
Maximum Linear Excursion	Xmax	mm	6.1		Test Spectrum Bandwidth		35Hz - 20kHz
Ferrofluid Type	FF				Driver Size	Inch	6 in
Driver Mass	Kg		1.04				

## Frequency and Impedance Response

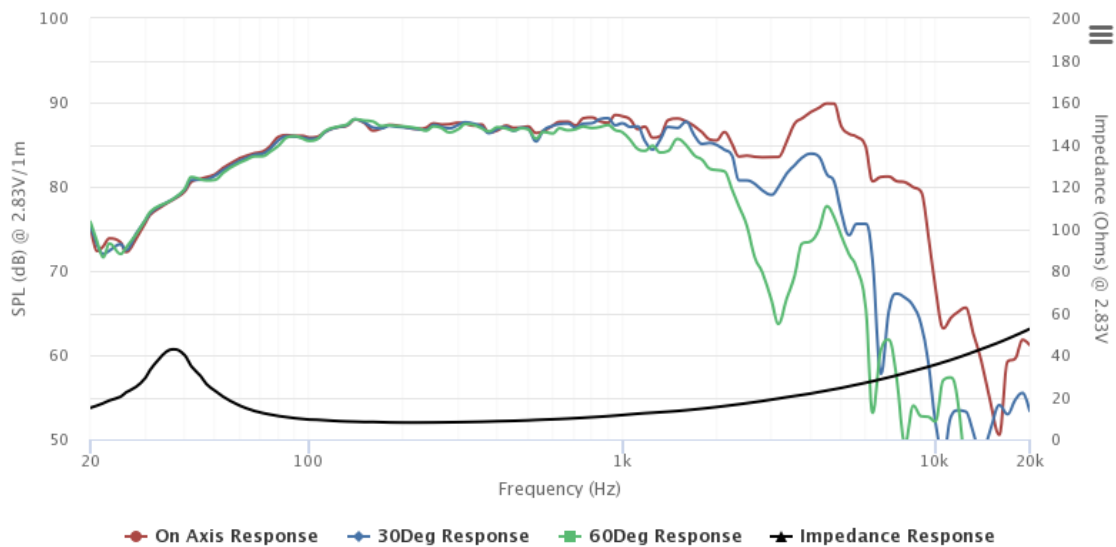

Highcharts.com