

Model No.: XT25SC90-04

Rev: 1

Product Line: Tymphany

Last Update: 2017-04-25 21:32:09

Product Description

This member of the XT tweeter family utilizes two Tymphany technologies to deliver exceptional sound quality: the ring radiator patent, and the central waveguide patent. This model features a 4 ohm 25 mm voice coil, mounted in a neodymium magnet motor. The tweeter also features a rear chamber to create extended low frequency response. The faceplate features recessed mounting holes which minimizes reflections off of mounting screws.



Mechanical Drawing

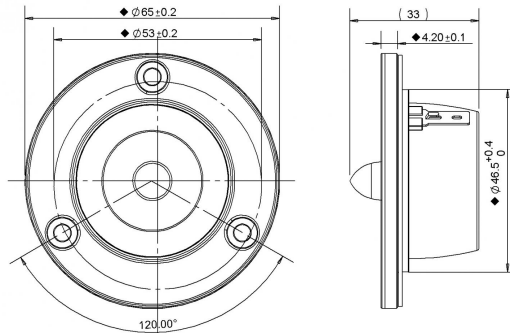

Specifications

DC Resistance	Revc	Ohms	3.13	5.0%	Energy Bandwidth Product	EBP	(1/Qes)*fs
Minimum Impedance	Zmin	Ohms	3.72	7.5%	Moving Mass	Mms	g
Voice Coil Inductance	Le	mH	0.01		Suspension Compliance	Cms	um/N
Resonant Frequency	Fs	Hz	824.75	15%	Effective Cone diameter	D	cm
Mechanical Q Factor	Qms		7.17		Effective Piston Area	Sd	cm ²
Electrical Q Factor	Qes		1.07		Effective Volume	Vas	L
Total Q Factor	Qts		0.93		Motor Force Factor	BL	Tm
Ratio Fs/Qts	F	Fs/Qts	887.78		Motor Efficiency Factor	β	(T*M ²)/Ohms
Half Space Sensitivity @2.83V	db@2.83V/1M	dB	90.14	+/- 1.0db	Voice coil former Material	VCfm	ASV
Half Space Sensitivity @1W/1M	db@1W/1M	dB	86.8	+/- 1.0db	Voice coil inner diameter	VCd	mm
Gap Height	Gh	mm	2		Rated Noise Power	P	W
Maximum Linear Excursion	Xmax	mm	0.1		Test Spectrum Bandwidth		800Hz - 20kHz
Ferrofluid Type	FF				Driver Size	Inch	25 mm
Driver Mass	Kg		0.07				

Frequency and Impedance Response

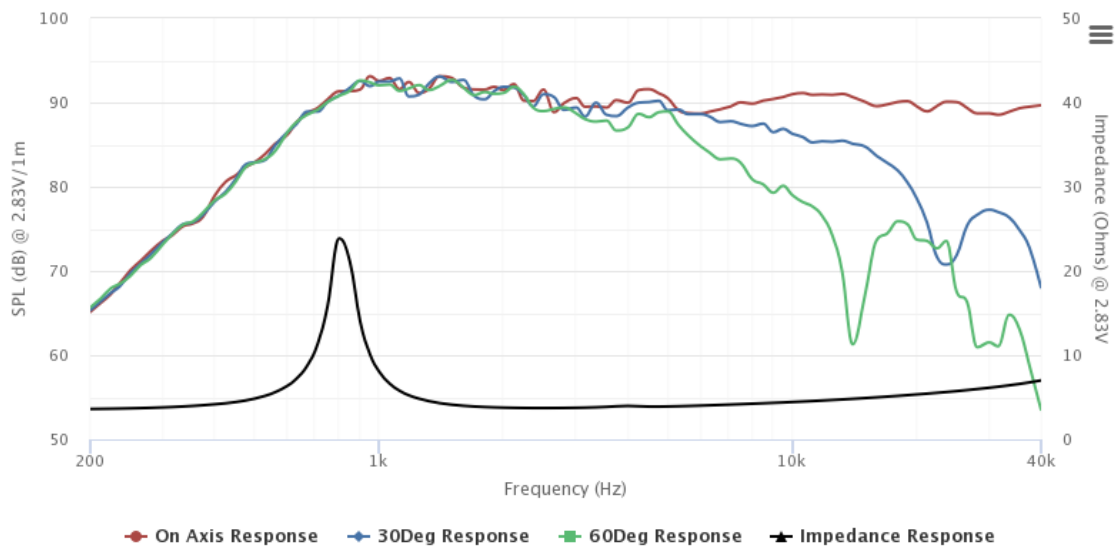

Highcharts.com