

Model No.: BC25SC15-04
 Product Line: Tymphany

Rev: 1
 Last Update: 2017-05-10 19:37:28

Product Description

The BC family of tweeters features a damped fabric dome for smooth frequency response performance and ferrofluid in the gap of the NdFeB magnet motor, providing enhanced cooling of the voice coil. BC tweeters come with a compact faceplate with recessed mounting holes, complete with sealing gasket which helps reduce vibration between baffle and driver.



Mechanical Drawing

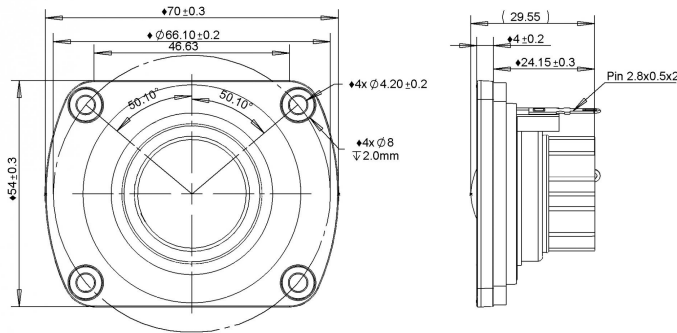

Specifications

DC Resistance	Revc	Ohms	2.92	5.0%	Energy Bandwidth Product	EBP	(1/Qes)*fs
Minimum Impedance	Zmin	Ohms	3.41	7.5%	Moving Mass	Mms	g
Voice Coil Inductance	Le	mH	0.02		Suspension Compliance	Cms	um/N
Resonant Frequency	Fs	Hz	1455.04	15%	Effective Cone diameter	D	cm
Mechanical Q Factor	Qms		2.76		Effective Piston Area	Sd	cm ²
Electrical Q Factor	Qes	1.89			Effective Volume	Vas	L
Total Q Factor	Qts		1.12		Motor Force Factor	BL	Tm
Ratio Fs/Qts	F	Fs/Qts	1297.98		Motor Efficiency Factor	β	(T*M ²)/Ohms
Half Space Sensitivity @2.83V	db@2.83V/1M	dB	93.04	+/- 1.0db	Voice coil former Material	VCfm	ASV
Half Space Sensitivity @1W/1M	db@1W/1M	dB	89.3	+/- 1.0db	Voice coil inner diameter	VCd	mm
Gap Height	Gh	mm	2		Rated Noise Power	P	W
Maximum Linear Excursion	Xmax	mm	0		Test Spectrum Bandwidth		2.5kHz - 20kHz
Ferrofluid Type	FF		APG O27n		Driver Size	Inch	25 mm
Driver Mass	Kg	0.07					

Frequency and Impedance Response

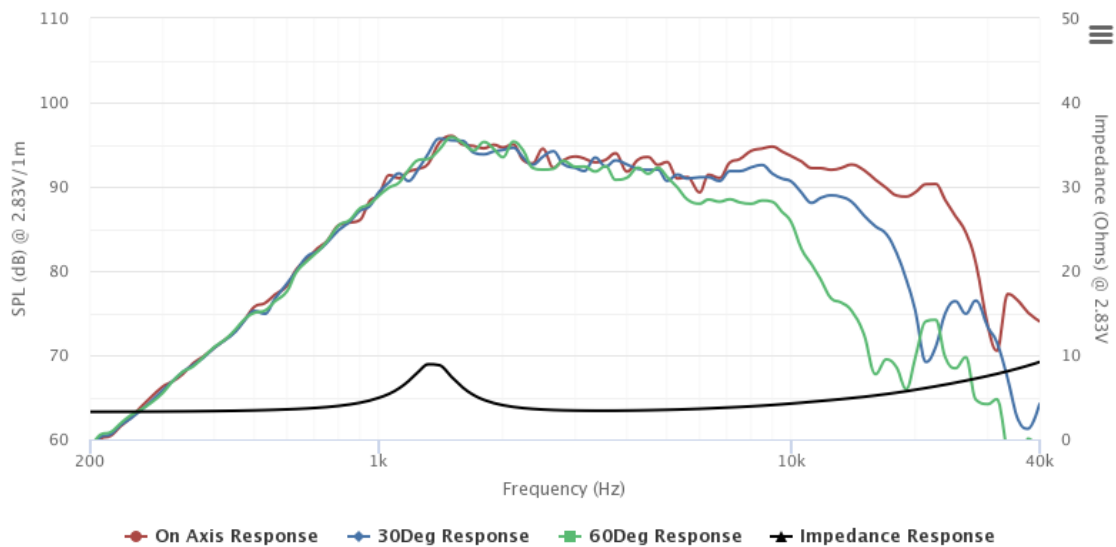

Highcharts.com