

Model No.: FSL-1015R02-08
 Product Line: Tymphany

Rev: 1
 Last Update: 2019-06-04 01:43:25

Product Description

This 10 inch, 8 ohm speaker features a FEA optimized ferrite magnet motor, a 1.5 inch high-temperature voice coil, and a high strength stamped steel frame. Kevlar loaded non-pressed paper cone to help dampen and control cone resonance. The multi-roll surround and spider have been optimized to reduce distortion over the excursion range of this transducer.



Mechanical Drawing

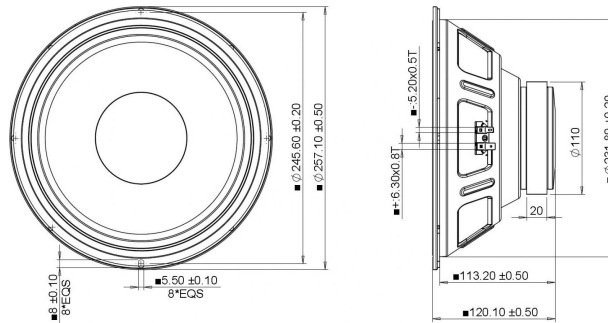

Specifications

DC Resistance	Revc	Ohms	5.47	5.0%	Energy Bandwidth Product	EBP	(1/Qes)*fs
Minimum Impedance	Zmin	Ohms	6.03	7.5%	Moving Mass	Mms	g
Voice Coil Inductance	Le	mH	0.48		Suspension Compliance	Cms	um/N
Resonant Frequency	Fs	Hz	68.41	15%	Effective Cone diameter	D	cm
Mechanical Q Factor	Qms		4.25		Effective Piston Area	Sd	cm^2
Electrical Q Factor	Qes		0.72		Effective Volume	Vas	L
Total Q Factor	Qts		0.62		Motor Force Factor	BL	Tm
Ratio Fs/Qts	F	Fs/Qts	110.88		Motor Efficiency Factor	β	(T*M^2)/Ohms
Half Space Sensitivity @2.83V	db@2.83V/1M	dB	94.49	+/- 1.0db	Voice coil former Material	VCfm	KSV
Half Space Sensitivity @1W/1M	db@1W/1M	dB	93.3	+/- 1.0db	Voice coil inner diameter	VCd	mm
Gap Height	Gh	mm	6		Rated Noise Power	P	W
Maximum Linear Excursion	Xmax	mm	2.2		Test Spectrum Bandwidth		70Hz-700Hz
Ferrofluid Type	FF				Driver Size	Inch	10 in
Driver Mass	Kg		2.1				

Frequency and Impedance Response

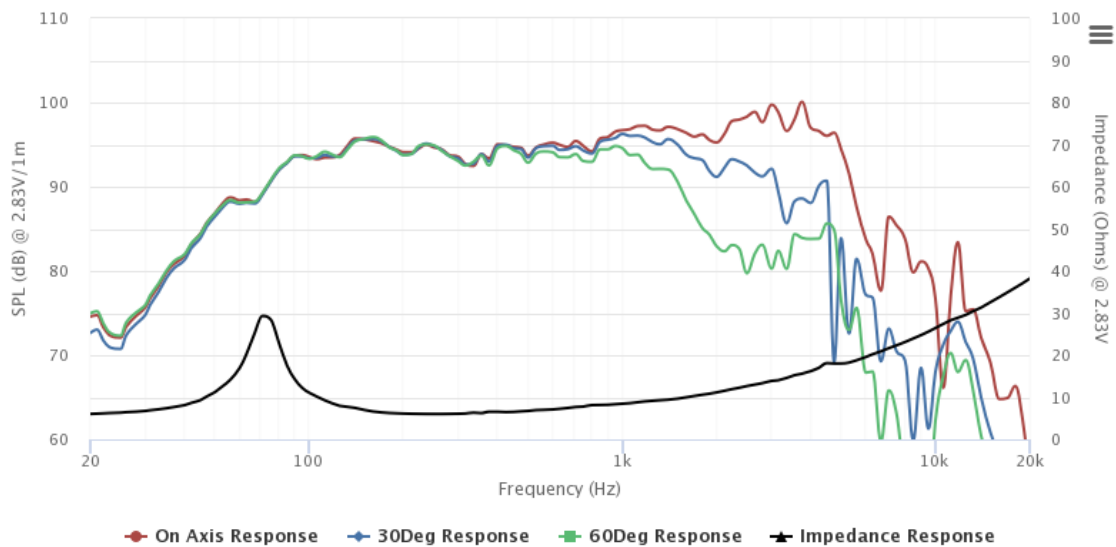

Highcharts.com