

Model No.: FSL-1530R01-08
 Product Line: Tymphany

Rev: 1
 Last Update: 2017-04-25 21:32:09

Product Description

This 15 inch 8 ohm speaker features a FEA optimized ferrite magnet motor, 2.5inch voice coil, cloth surround, paper cone, a vented yoke for motor cooling, and a high strength stamped steel frame. Kevlar loaded non-pressed paper cone to help dampen and control cone resonance. The multi-roll surround and spider have been optimized to reduce distortion over the excursion range of this transducer.



Mechanical Drawing

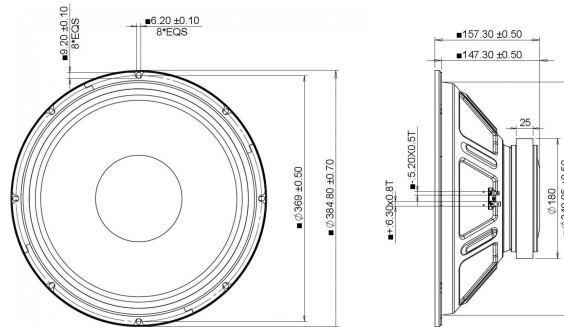

Specifications

DC Resistance	Revc	Ohms	5.23	5.0%	Energy Bandwidth Product	EBP	(1/Qes)*fs
Minimum Impedance	Zmin	Ohms	7.51	7.5%	Moving Mass	Mms	g
Voice Coil Inductance	Le	mH	1.16		Suspension Compliance	Cms	um/N
Resonant Frequency	Fs	Hz	40.43	15%	Effective Cone diameter	D	cm
Mechanical Q Factor	Qms		5.85		Effective Piston Area	Sd	cm^2
Electrical Q Factor	Qes		0.25		Effective Volume	Vas	L
Total Q Factor	Qts		0.24		Motor Force Factor	BL	Tm
Ratio Fs/Qts	F	Fs/Qts	168.46		Motor Efficiency Factor	β	(T*M^2)/Ohms
Half Space Sensitivity @2.83V	db@2.83V/1M	dB	98.4	+/- 1.0db	Voice coil former Material	VCfm	GSV
Half Space Sensitivity @1W/1M	db@1W/1M	dB	98.1	+/- 1.0db	Voice coil inner diameter	VCd	mm
Gap Height	Gh	mm	8		Rated Noise Power	P	W
Maximum Linear Excursion	Xmax	mm	2.2		Test Spectrum Bandwidth		40Hz-400Hz
Ferrofluid Type	FF				Driver Size	Inch	15 in
Driver Mass	Kg		6.3				

Frequency and Impedance Response

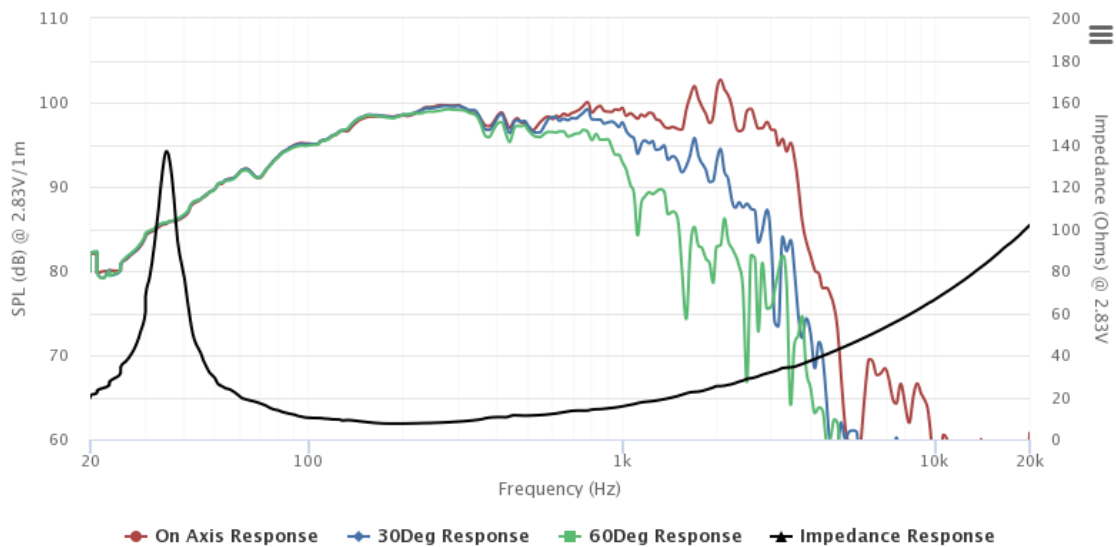

Highcharts.com