

Model No.: HDS-P830883
 Product Line: Tymphany

Rev: 1
 Last Update: 2017-03-03 09:00:02

Product Description

This 6.5 inch 8 ohm driver is a member of the high performance HDS family. A powerful ferrite magnet system is coupled to a finite element analysis designed suspension system, containing both a linear spider design and a rubber surround. The motor contains an aluminium shorting ring, which reduces coil inductance, thus providing both extended frequency response performance and reduced distortion. The long-throw voice coil ensures linear high excursion performance, needed for signal clarity. The driver employs a phase plug for low compression and frequency response shaping without the use of a dust cap. The cast aluminium basket offers structural rigidity, heat sinking capacity for the motor, and additional air venting under the spider so as to again reduce air compression effects. The cone in this model is nomex based, offering a unique visual and acoustic experience.



Mechanical Drawing

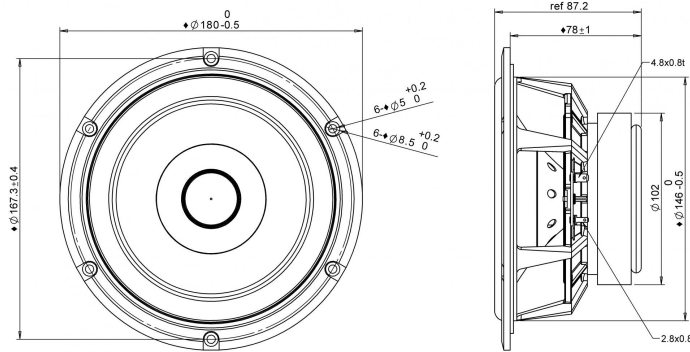

Specifications

DC Resistance	Revc	Ohms	5.85	5.0%	Energy Bandwidth Product	EBP	(1/Qes)*fs
Minimum Impedance	Zmin	Ohms	6.67	7.5%	Moving Mass	Mms	g
Voice Coil Inductance	Le	mH	0.18		Suspension Compliance	Cms	um/N
Resonant Frequency	Fs	Hz	42.85	15%	Effective Cone diameter	D	cm
Mechanical Q Factor	Qms		2.18		Effective Piston Area	Sd	cm^2
Electrical Q Factor	Qes		0.46		Effective Volume	Vas	L
Total Q Factor	Qts		0.38		Motor Force Factor	BL	Tm
Ratio Fs/Qts	F	Fs/Qts	112.77		Motor Efficiency Factor	β	(T*M^2)/Ohms
Half Space Sensitivity @2.83V	db@2.83V/1M	dB	87.46	+/- 1.0db	Voice coil former Material	VCfm	ASV
Half Space Sensitivity @1W/1M	db@1W/1M	dB	86.7	+/- 1.0db	Voice coil inner diameter	VCd	mm
Gap Height	Gh	mm	6		Rated Noise Power	P	W
Maximum Linear Excursion	Xmax	mm	5.6		Test Spectrum Bandwidth		40Hz - 3kHz
Ferrofluid Type	FF				Driver Size	Inch	6 Inch
Driver Mass	Kg		1.64				

Frequency and Impedance Response

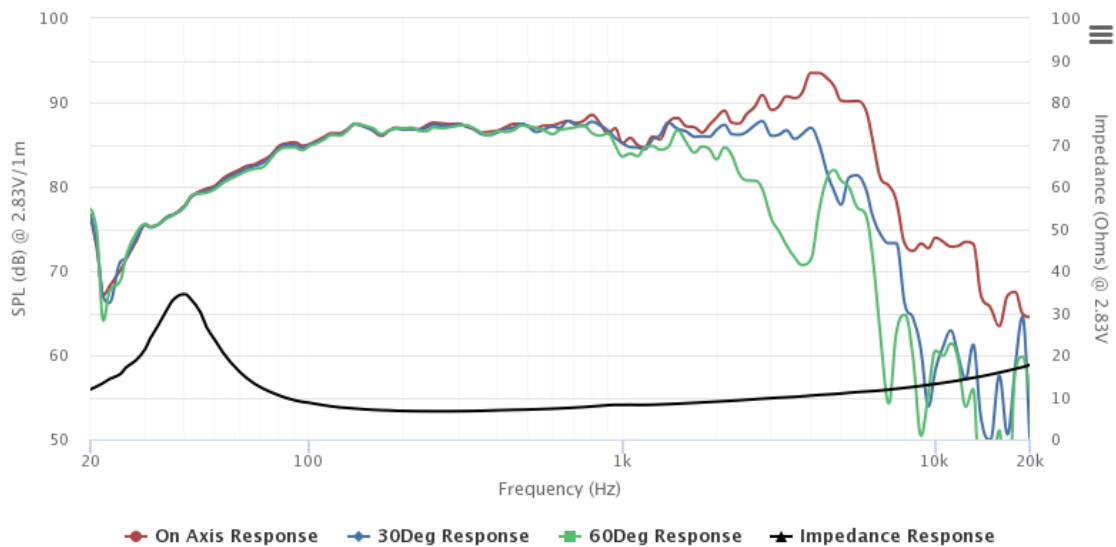

Highcharts.com