

Model No.: NE19VTC-04

Product Line: Tymphany

Rev: 1

Last Update: 2017-05-10 14:54:07

Product Description

The NE family has leading-edge transducer technology packaged in a cutting edge, stylistic design. The 4 ohm 19 mm tweeters in this family feature finite element analysis designed Neodymium-Iron-Boron magnet (NdFeB) motors, with copper caps for extended frequency response and reduced distortion. The aluminium rear chambers offer extended low frequency performance, while doubling as heat sinking. The butterfly supporting the tweeter diaphragm is made of a high temperature plastic, consistent with the products high temperature performance rating, and features supporting terminals. The dome material in this design is deep-anodized aluminum, and the design has been optimized for sound quality and clarity. Rounding out the design is an aluminium face plate and plastic grille, which offers protection for the tweeter diaphragm.



Mechanical Drawing

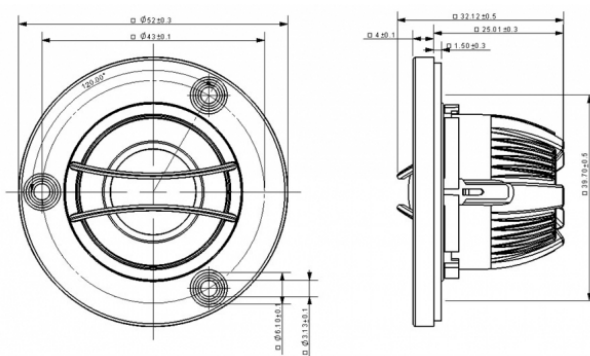

Specifications

DC Resistance	Revc	Ohms	2.71	5.0%	Energy Bandwidth Product	EBP	(1/Qes)*fs
Minimum Impedance	Zmin	Ohms	3.28	7.5%	Moving Mass	Mms	g
Voice Coil Inductance	Le	mH	0.01		Suspension Compliance	Cms	um/N
Resonant Frequency	Fs	Hz	769.17	15%	Effective Cone diameter	D	cm
Mechanical Q Factor	Qms		4.5		Effective Piston Area	Sd	cm^2
Electrical Q Factor	Qes		1.65		Effective Volume	Vas	L
Total Q Factor	Qts		1.21		Motor Force Factor	BL	Tm
Ratio Fs/Qts	F	Fs/Qts	636.73		Motor Efficiency Factor	β	(T*M^2)/Ohms
Half Space Sensitivity @2.83V	db@2.83V/1M	dB	86.67	+/- 1.0db	Voice coil former Material	VCfm	ASV
Half Space Sensitivity @1W/1M	db@1W/1M	dB	82.8	+/- 1.0db	Voice coil inner diameter	Vcd	mm
Gap Height	Gh	mm	2		Rated Noise Power	P	W
Maximum Linear Excursion	Xmax	mm	0.1		Test Spectrum Bandwidth		2.5kHz - 20kHz
Ferrofluid Type	FF				Driver Size	Inch	19 mm
Driver Mass	Kg		0				

Frequency and Impedance Response

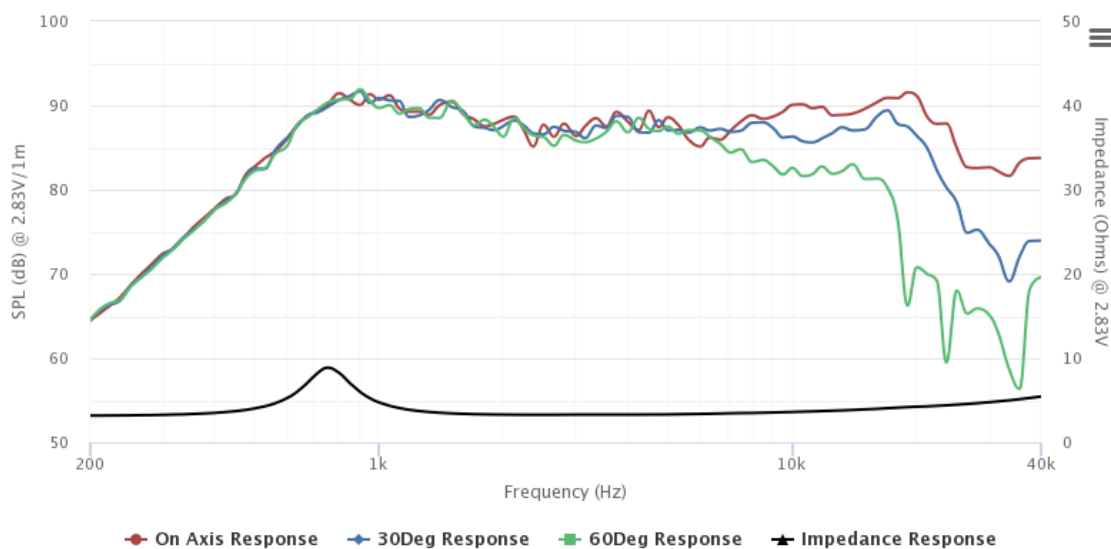

Highcharts.com